

Oscillator

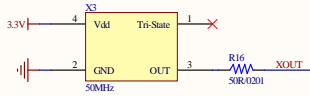

FPGA 1V2

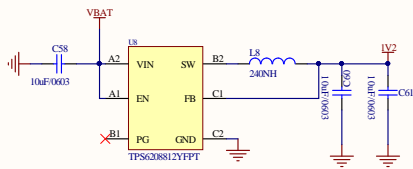

FPGA 3V3

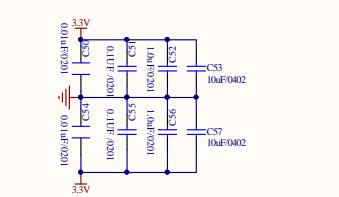
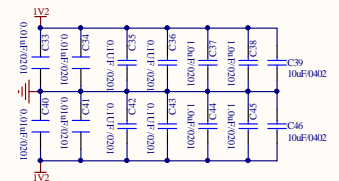
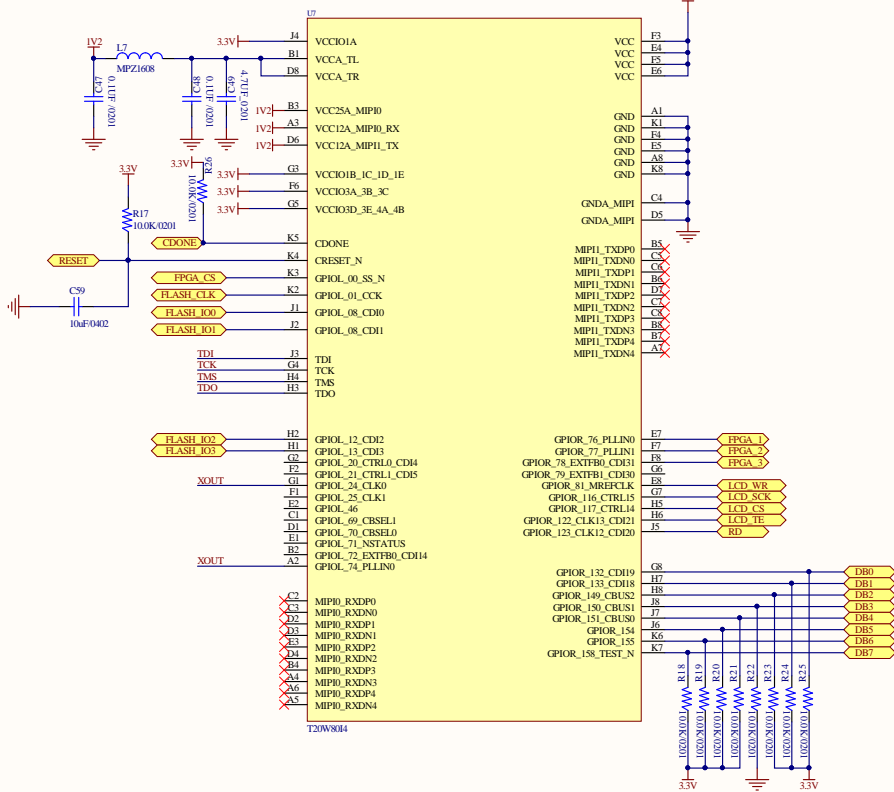
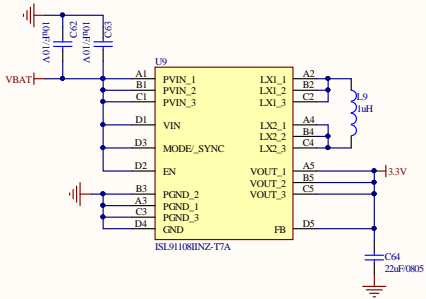

JTAG

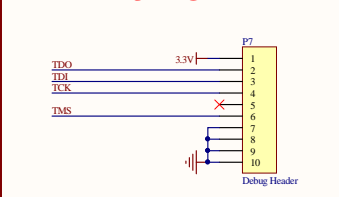

Title:		
Site:	Number:	Revision:
A		
Date:	7/14/2021	Sheet of
File:	D:\Data\...T20_FPGA_SchDoc	Drawn By: